

User's Guide

EVGA P55 SLI Motherboard

Table of Contents

User's Guide	1
EVGA P55 SLI Motherboard	1
Before You Begin... ..	7
Parts NOT in the Kit	7
EVGA P55 SLI Motherboard	8
Motherboard Specifications.....	8
Hardware Installation	10
Safety Instructions.....	10
Preparing the Motherboard	11
Installing the CPU	11
Installing the CPU Fan	12
Installing System Memory (DIMMs)	13
Installing the Motherboard.....	13
Installing the I/O Shield	14
Securing the Motherboard into a System Case	15
Connecting Cables.....	15
24-pin ATX Power (PW1).....	16
8-pin ATX 12V Power (PW12)	16
Connecting Serial ATA Cables.....	16
Connecting Internal Headers	18
Front Panel Header	18
IEEE1394a (Firewire).....	19
USB Headers	20

Audio	21
Expansion Slots	22
PCI Slots	22
PCI Express x1 Slots	22
PCI Express x16/x8/x4 Slots	22
Onboard Buttons	23
Clear CMOS Button	23
RESET and POWER Button	23
Post Port Debug LED and LED Status Indicators	24
Post Port Debug LED	24
LED Status Indicators	24
Configuring the BIOS	25
Enter BIOS Setup	26
Main Menu	26
Standard BIOS Features Menu	28
System Time / System Date	29
Advanced BIOS Features	29
IDE Configuration	30
Boot Settings Configuration	30
AHCI Configuration	30
Intel VT-d Configuration	31
USB Configuration	31
Advanced Chipset Features	31
North Bridge Configuration	31
PCI Express Configuration	32
PCI/PNP Resource Management	34
Clear NVRAM	34
Plug & Play O/S	34
PCI Latency Timer	34
Allocate IRQ to PCI VGA	35

Palette Snooping	35
PCI IDE BusMaster	35
OffBoard PCI/ISA IDE Card	35
Boot Configuration Features	36
Boot Device Priority.....	36
Hard Disk Drives	36
Power Management Features.....	37
ACPI Configuration	37
SLP_S4# Min. Assertion Width	38
Restore on AC Power Loss.....	38
Hardware Health Configure.....	38
H/W Health Function	38
CPU Fan Mode Setting	39
Frequency/Voltage Control Menu	39
Memory Configure.....	39
CPU Configuration	40
Installing Drivers and Software	41
Windows XP/Vista/7 Driver Installation	41
Appendix A. POST Codes for the EVGA P55 SLI Motherboard	42

List of Figures

Figure 1.	PW1 Motherboard Connector	16
Figure 2.	CMOS Setup Utility Main Menu	27
Figure 3.	Standard BIOS Features Menu.....	28
Figure 4.	Advanced BIOS Features	30
Figure 5.	Advanced Chipset Features.....	31
Figure 6.	PCI/PNP Resource Management	34
Figure 7.	Boot Configuration Features	36
Figure 8.	Power Management Features.....	37
Figure 9.	Hardware Health Configure.....	38
Figure 10.	Frequency/Voltage Control	39

Before You Begin...

Parts NOT in the Kit

This kit contains all the hardware necessary to install and connect your new EVGA P55 SLI Motherboard. However, it does not contain the following items that must be purchased separately to make the motherboard functional.

- ❑ **Intel Socket 1156 Processor**
- ❑ **DDR3 System Memory**
- ❑ **Socket 1156 or Socket 775 Cooling fan**
- ❑ **PCI Express or PCI Graphics Card**
- ❑ **Power Supply**

EVGA assumes you have purchased all the necessary parts needed to allow for proper system functionality. For a full list of supported CPU's on this motherboard, please visit <http://www.evga.com/support/motherboard/>.

When replacing a motherboard in a system case, you will need to reinstall an operating system even though the current hard disk may already have an operating system.

EVGA P55 SLI Motherboard

Motherboard Specifications

- ❑ Size
ATX form factor of 12 inch x 9.6 inch
- ❑ Processor support
Intel Socket 1156 CPU's
- ❑ Operating systems:
Supports Windows XP 32bit/64bit, Windows Vista 32bit/64bit, and
Windows 7 32bit/64bit
- ❑ Intel P55 Express Chipset
- ❑ System Memory support
Supports dual channel DDR3-1600+. Officially supports up to 16GBs of
DDR3 memory.
- ❑ USB 2.0 Ports
Supports hot plug
Thirteen USB 2.0 ports (Seven rear panel ports, six onboard USB headers)
Supports wake-up from S1 and S3 mode
Supports USB 2.0 protocol up to a 480 Mbps transmission rate

- ❑ Six(6) onboard Serial ATA II
 - 300MBps data transfer rate
 - Six Serial ATA II connectors with support for RAID 0, RAID 1, RAID 10, and RAID 5
 - Supports hot plug and NCQ (Native Command Queuing)
- ❑ Dual Onboard LAN's
 - Integrated LAN port's
 - Supports 10/100/1000 Mb/sec Ethernet
- ❑ Onboard IEEE1394a (Firewire)
 - Support hot plug
 - Two IEEE1394a ports (One rear panel port, one onboard 1394 header) with a rate transmission of 400 Mbps
- ❑ Onboard Audio
 - Realtek High-Definition audio
 - Supports 8-channel audio
 - Supports S/PDIF output (Optical and COAX)
 - Supports Jack-Sensing function
- ❑ Green Function
 - Supports ACPI (Advanced Configuration and Power Interface)
 - Supports S0 (normal), S1 (power on suspend), S3 (suspend to RAM), S4 (Suspend to disk - depends on OS), and S5 (soft - off)
- ❑ Expansion Slots
 - Two PCI slots
 - One PCI Express x1 slot
 - Three PCI Express x4/x8/x16 slots
- ❑ e-SATA
 - Two e-SATA ports at rear panel
 - 300MBps data transfer rate

Hardware Installation

This section will guide you through the installation of the motherboard. The topics covered in this section are:

- ❑ Preparing the motherboard
- ❑ Installing the CPU
- ❑ Installing the CPU fan
- ❑ Installing the memory
- ❑ Installing the motherboard
- ❑ Connecting cables

Safety Instructions

To reduce the risk of fire, electric shocks, and injury, always follow basic safety precautions.

Remember to remove power off your computer by disconnecting the AC main source before removing or installing any equipment from/to the computer chassis.

Preparing the Motherboard

Installing the CPU

Be very careful when handling the CPU. Hold the processor only by the edges and do not touch the contacts on the motherboard or CPU. **Any physical damage to the motherboard pins will void the warranty.**

Use the following procedure to install the CPU onto the motherboard:

Unhook the socket lever by pushing *down* and *away* from the socket.

Pull the socket lever back and the load plate will automatically lift. There is a protective socket cover within the CPU socket to protect the socket when there is no CPU installed.

Remove the protective socket cover from the CPU Socket in a straight up motion.

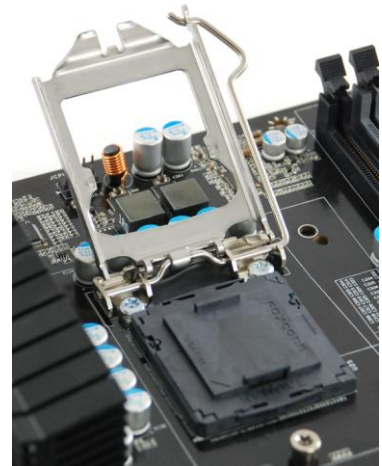
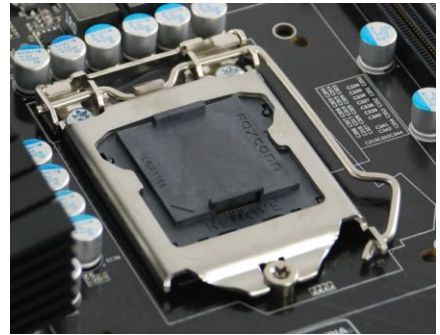

Note: It is a good idea to save the cover so that whenever you remove the CPU you have a safe place to store it.

Align the notches in the processor with the notches on the socket.

Lower the processor straight down into the socket without tilting or sliding it into the socket

Note: Make sure the CPU is fully seated and level.

Lower the load plate so it is resting on the CPU.

Pull back the socket lever again to ensure the load plate tip engages under the shoulder screw cap.

Carefully close and latch the lever.

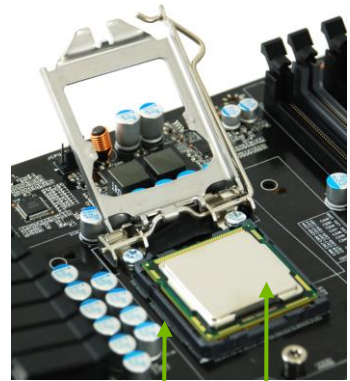

Align notches with notches on the CPU

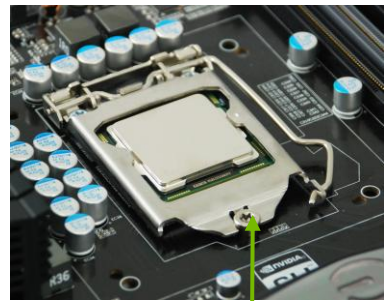

Load plate tip under screw cap

Installing the CPU Fan

There are many different fan types that can be used with this motherboard. Follow the instruction that came with you fan assembly. Be sure that the fan orientation is correct for your chassis type and your fan assembly.

Please note that there are 2 sets of mounting holes, the holes surrounded in white are to be used for Socket 1156 heatsinks and are labeled. The other holes are to be used for Socket 775 heatsinks.

In most cases, the Socket 1156 mounting holes will be used.

Installing System Memory (DIMMs)

Your new motherboard has four 240-pin slots for DDR3 memory. These slots support 1GB, 2GB, 4GB DDR3 technologies. There must be at least one memory bank populated to ensure normal operation. Use the following the recommendations for installing memory.

- ❑ **One DIMM:** If using 1 DIMM (**Single Channel**), install into: **DIMM slot 1.**
- ❑ **Two DIMMs:** If using 2 DIMMs (**Dual Channel**), install into: **DIMM slots 1 and 3.**
- ❑ **Four DIMMs:** If using 4 DIMMs (**Dual Channel**), install into: **DIMM slots 2, 1, 4, and 3.**



Use the following procedure to install memory DIMMs. Note that there is only one gap near the center of the DIMM slot. This slot matches the slot on the memory DIMM to ensure the component is installed properly.

1. Unlock a DIMM slot by pressing the module clips outward.
2. Align the memory module to the DIMM slot, and insert the module vertically into the DIMM slot. The plastic clips at both sides of the DIMM slot automatically lock the DIMM into the connector.

Installing the Motherboard

The sequence of installing the motherboard into a system case depends on the chassis you are using and if you are replacing an existing motherboard or working with an empty system case. Determine if it would be easier to make all the connections prior to this step or to secure the motherboard and then make all the connections. It is normally easier to secure the motherboard first.

Use the following procedure to install the I/O shield and secure the motherboard into the chassis.

Installing the I/O Shield

The motherboard kit comes with an I/O shield that is used to block radio frequency transmissions, protects internal components from dust and foreign objects, and promotes correct airflow within the chassis.

Before installing the motherboard, install the I/O shield from the *inside* of the chassis. Press the I/O shield into place and make sure it fits securely.

Securing the Motherboard into a System Case

Most system cases have a base with mounting studs or spacers to allow the motherboard to be secured to the chassis and help to prevent short circuits. If there are studs that do not align with a mounting hole on the motherboard, it is recommended that you remove that stud to prevent the possibility of a short circuit. In most cases, it is recommended to secure the motherboard using a minimum of nine (9) spacers and screws.

1. Carefully place the motherboard onto the stand offs located inside the chassis.
2. Align the mounting holes with the stand offs.
3. Align the connectors to the I/O shield.
4. Ensure that the fan assembly is aligned with the chassis vents according to the fan assembly instruction.
5. Secure the motherboard with a recommended minimum of nine (9) screws.

Connecting Cables

This section takes you through all the necessary connections on the motherboard. This will include:

- ❑ Power Connections
 - 24-pin ATX power (**PW1**)
 - 8-pin ATX 12V power (**PW12**)
- ❑ Internal Headers
 - Front panel
 - IEEE 1394a
 - USB Headers
 - Audio
- ❑ Serial ATA II
- ❑ USB 2.0
- ❑ Expansion slots
- ❑ CMOS Clear Button

24-pin ATX Power (PW1)

PW1 is the main power supply connector located along the edge of the board next to the DIMM slots. Make sure that the power supply cable and pins are properly aligned with the connector on the motherboard. Firmly plug the power supply cable into the connector and make sure it is secure.



PW1 connector
Plug power cable from system power supply to PW1

Figure 1. PW1 Motherboard Connector

Table 1. PW1 Pin Assignments

Connector	Pin	Signal	Pin	Signal
	1	+3.3V	13	+3.3V
	2	+3.3V	14	-12V
	3	GND	15	GND
	4	+5V	16	PS_ON
	5	GND	17	GND
	6	+5V	18	GND
	7	GND	19	GND
	8	PWROK	20	RSVD
	9	+5V_AUX	21	+5V
	10	+12V	22	+5V
	11	+12V	23	+5V
	12	+3.3V	24	GND

8-pin ATX 12V Power (PW12)

PW12, the 8-pin ATX 12V power connection, is used to provide power to the CPU. Align the pins to the connector and press firmly until seated.

Connecting Serial ATA Cables

The Serial ATA II connector is used to connect the Serial ATA II device to the motherboard. These connectors support the thin Serial ATA II cables for

primary storage devices. The current Serial ATA II interface allows up to 300MB/s data transfer rate.

There are six (6) internal serial ATA connectors on this motherboard. These connections are designed to be angled to not interfere with any expansions cards. These connection points support RAID 0, RAID 1, and RAID 10 configurations.

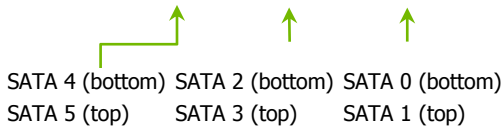
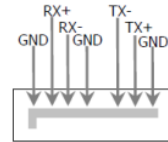
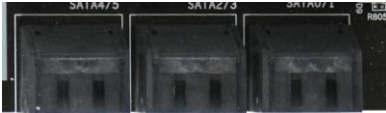

Connecting Internal Headers

Front Panel Header

The front panel header on this motherboard is one connector used to connect the following four cables.

(see Table 2 for pin definitions):

❑ PWRLED

Attach the front panel power LED cable to these two pins of the connector. The Power LED indicates the system's status. When the system is turned on, the LED is on. When the system is turned off, the LED is off.

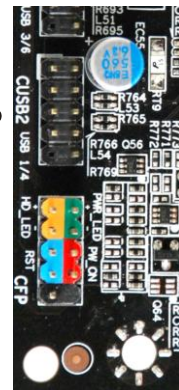
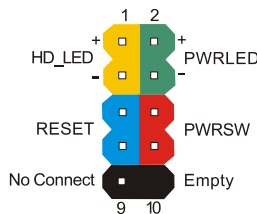

Note: Some system cases do not have all four cables. Be sure to match the name on the connectors to the corresponding pins.

❑ PWRSW

Attach the power button cable from the case to these two pins. Pressing the power button on the front panel turns the system on and off rather than using the onboard button.

❑ HD_LED

Attach the hard disk drive indicator LED cable to these two pins. The HDD indicator LED indicates the activity status of the hard disks.

❑ RESET

Attach the Reset switch cable from the front panel of the case to these two pins. The system restarts when the **RESET** switch is pressed.

Table 2. Front Panel Header Pins

	Pin	Signal
HD_LED	1	HD_PWR
	3	HD Active
PWRLED	2	PWR LED
	4	STBY LED
RESET	5	Ground
	7	RST BTN
PWRSW	6	PWR BTN
	8	Ground
No Connect	9	+5V
Empty	10	Empty

IEEE1394a (Firewire)

This motherboard has one IEEE 1394a onboard header. Alternatively, you can also connect this to your system case (if applicable).

1. Secure the bracket to either the front or rear panel of the system case (not all system cases are equipped with the front panel option).

Connect the end of the cable to the IEEE1394a header on the motherboard.

Table 3. IEEE 1394a Connector Pins

Connector	Pin	Signal
IEEE 1394a Connector	1	TPA+
	2	TPA-
	3	GND
	4	GND
	5	TPB+
	6	TPB-
	7	+12V
	8	+12V
	9	Empty
	10	GND

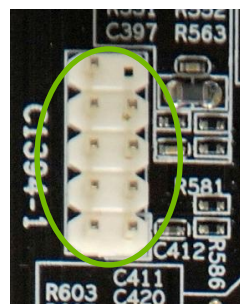
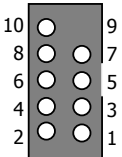

USB Headers

This motherboard contains seven (7) USB 2.0 ports that are exposed on the rear panel of the chassis (Figure 2). The motherboard also contains three (3) 10-pin internal header connectors onboard that can be used to connect an optional external bracket containing up to six (6) USB 2.0 ports.



1. Secure the bracket to either the front or rear panel of your chassis (not all chassis are equipped with the front panel option).
2. Connect the end of the cable(s) to the USB 2.0 header on the motherboard.

Table 4. USB 2.0 Header Pins

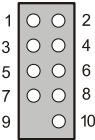
Connector	Pin	Signal
USB 2.0 Header Connector 	1	5V_DUAL
	3	D-
	5	D+
	7	GND
	9	Empty
	Pin	Signal
	2	5V_DUAL
	4	D-
	6	D+
	8	GND
10	No Connect	

Audio

The audio connector supports HD audio standard and provides two kinds of audio output choices: the Front Audio, the Rear Audio. The front Audio supports re-tasking function.

Table 5. Front Audio Connector

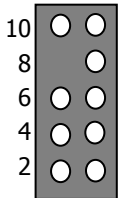
Connector	Pin	Signal
Front Audio Connector 	1	PORT1_L
	2	AUD_GND
	3	PORT1_R
	4	PRECENCE_J
	5	PORT2_R
	6	SENSE1_RETURN
	7	SENSE_SEND
	8	Empty
	9	PORT2_L
	10	SENSE2_RETURN

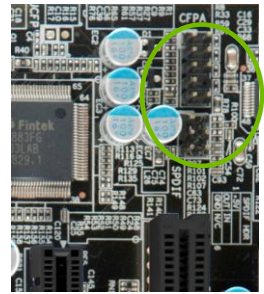

Expansion Slots

PCI Slots

The PCI slot supports many expansion cards such as a LAN card, USB card, SCSI card and other cards that comply with PCI specifications. When installing a card into the PCI slot, be sure that it is fully seated. Secure the card's metal bracket to the chassis back panel with the screw used to hold the blank cover.

PCI Express x1 Slots

There is one PCI Express x1 slot that is designed to accommodate PCIe x1 cards, such as an EVGA Killer Xeno Network Card or Sound Card. The x1 slot provides 250 MB/sec bandwidth.

PCI Express x16/x8/x4 Slots

These PCI Express slots are reserved for Graphic Cards and PCI Express x1 and x4 devices. The design of this motherboard supports multiple Graphic Card technology.

When installing a PCI Express Graphic Card, be sure the retention clip snaps and locks the card into place. If the card is not seated properly, it could cause a short across the pins. Secure the card's metal bracket to the chassis back panel with the screw used to hold the blank cover.

For SLI use, it is very important to use only slots PCI Express Slots 1 and 2 (primary and secondary) for optimal performance.

Post Port Debug LED and LED Status Indicators

Post Port Debug LED

Provides two-digit POST codes to show why the system may be failing to boot. It is useful during troubleshooting situations. This Debug LED will also display current CPU temperatures after the system has fully booted into the Operating System.

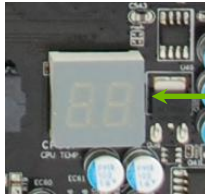

Debug LED with CPU Temperature Monitor

LED Status Indicators

The LEDs near the 24pin ATX connector indicate the system's status.

- POWER LED (Green):
When the System is powered on: This LED is on.
- DIMM LED (Orange):
When the Memory slot is functional: This LED is on.
- STANDBY LED (Blue):
When the System is in Standby Mode: This LED is on. This LED will remain on as long as the motherboard is receiving constant power.

Configuring the BIOS

This section discusses how to change the system settings through the BIOS Setup menus. Descriptions of the BIOS parameters are also provided.

This section includes the following information:

- ❑ Enter BIOS Setup
- ❑ Main Menu
- ❑ Standard BIOS Features
- ❑ Advanced BIOS Features
- ❑ Advanced Chipset Features
- ❑ PCI/PnP Resource Management
- ❑ Boot Configuration Features
- ❑ Power Management Features
- ❑ Hardware Health Configure
- ❑ Frequency/Voltage Control

Enter BIOS Setup

The BIOS is the communication bridge between hardware and software. Correctly setting the BIOS parameters is critical to maintain optimal system performance and stability.

Use the following procedure to verify/change BIOS settings.

3. Power on the computer.
4. Press the **Del** key when the following message briefly displays at the bottom of the screen during the Power On Self Test (POST).

Press F2 to Load Defaults, DEL to enter Setup.

Pressing **Del** takes you to the AMI BIOS CMOS Setup Utility.

Main Menu

The main menu allows you to select from the list of setup functions and two exit choices. Use the **+** and **-** keys to scroll through the options or press **Enter** to display the associated submenu. Use the **↑↓** arrow keys to position the selector in the option you choose. To go back to the previous menu, press **Esc**.

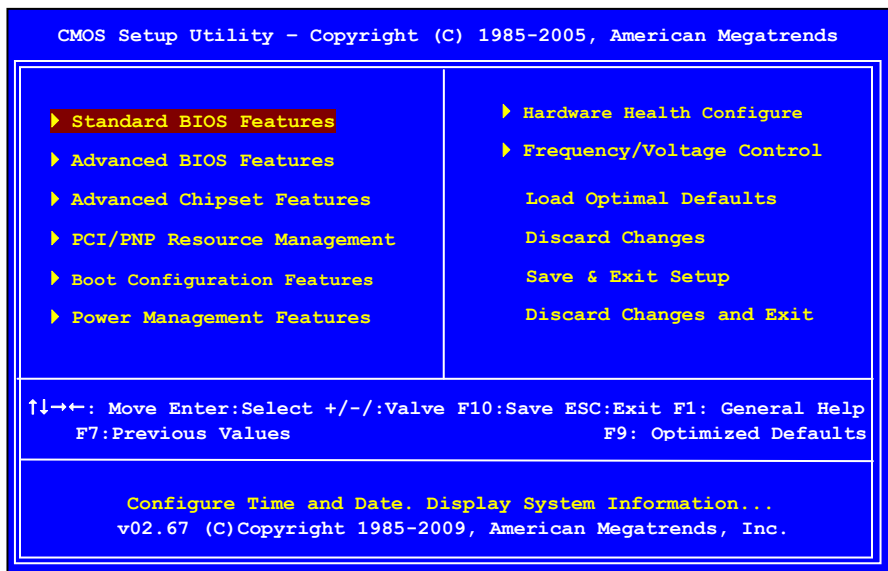

Figure 2. CMOS Setup Utility Main Menu

- ❑ **Standard BIOS Features**
Use this menu to set up the basic system configuration.
- ❑ **Advanced BIOS Features**
Use this menu to set up the advanced system features and boot sequence.
- ❑ **Advanced Chipset Features**
Use this menu to set up onboard peripherals such as IDE, RAID, USB, LAN, and MAC control.
- ❑ **PCI/PNP Resource Management**
Use this menu to configure resource management.
- ❑ **Boot Configuration Features**
Use this menu to modify the system's boot configuration.
- ❑ **Power Management Features**
Use this menu to modify power management, power on, and sleep features.
- ❑ **Hardware Health Configure**
Use this menu to view system vitals.
- ❑ **Frequency/Voltage Control**
Use this menu to optimize system performance and configure clocks, voltages, memory timings, and more.
- ❑ **Load Optimal Defaults**
Load default system settings.
- ❑ **Discard Changes**
Use this command to abandon all setting changes and exit setup.
- ❑ **Save Changes & Exit**
Use this command to save settings to CMOS and exit setup.
- ❑ **Discard Changes and Exit**
Use this command to abandon all setting changes and exit setup.

Standard BIOS Features Menu

The Standard CMOS Features menu is used to configure the standard CMOS information, such as the date, time, and so on. Use the **+** and **-** keys to scroll through the options. Use the **↑↓** arrow keys to position the selector in the option you choose. To go back to the previous menu, press **Esc**.

```
CMOS Setup Utility - Copyright (C) 1985-2005, American Megatrends
Standard BIOS Features

System Overview
-----
AMTBIOS
Version      :08.00.16
Build Date:07/16/10
ID           :1E655000

Processor
Intel(R) Core(TM) CPU      750 @ 2.67GHz
Speed        :2666MHz
Count        :1

System Memory
Size         :4088MB

System Time      [13:37:00]
System Date     [Fri 07/16/2010]

Help Item
-----
Use [ENTER] , [TAB]
Or [SHIFT-TAB] to
select a field.

Use [+] or [-] to
Configure system Time.

↑↓→←:Move  Enter:Select  +/-:Value  F10:Save  ESC:Exit  F1:General Help
F5:Previous Values      F7:Optimized Defaults
```

Figure 3. Standard BIOS Features Menu

System Time / System Date

Using the arrow keys, position the cursor over the month, day, and year. Use the **+** and **-** keys to scroll through dates and times. Note that the weekday (Sun through Sat) cannot be changed. This field changes to correspond to the date you enter. Note that the hour value is shown in a 24-hour clock format. Time is represented as **hour : minute : second**.

A screenshot of a BIOS configuration screen with a blue background. It shows two lines of text: 'System Time' followed by '[13:37:00]' and 'System Date' followed by '[Fri 07/16/2010]'. The numbers in the time and date fields are highlighted in red.

```
System Time      [13:37:00]
System Date      [Fri 07/16/2010]
```

Advanced BIOS Features

Access the Advanced BIOS Features menu from the CMOS Setup Utility screen. Use the **+** and **-** keys to scroll through the options or press **Enter** to display the sub-menu. Use the **↑↓** arrow keys to position the selector in the option you choose. To go back to the previous menu, press **Esc**.

The options that have associated sub-menus are designated by a **▶**, which precedes the option. Press **Enter** to display the sub-menus.

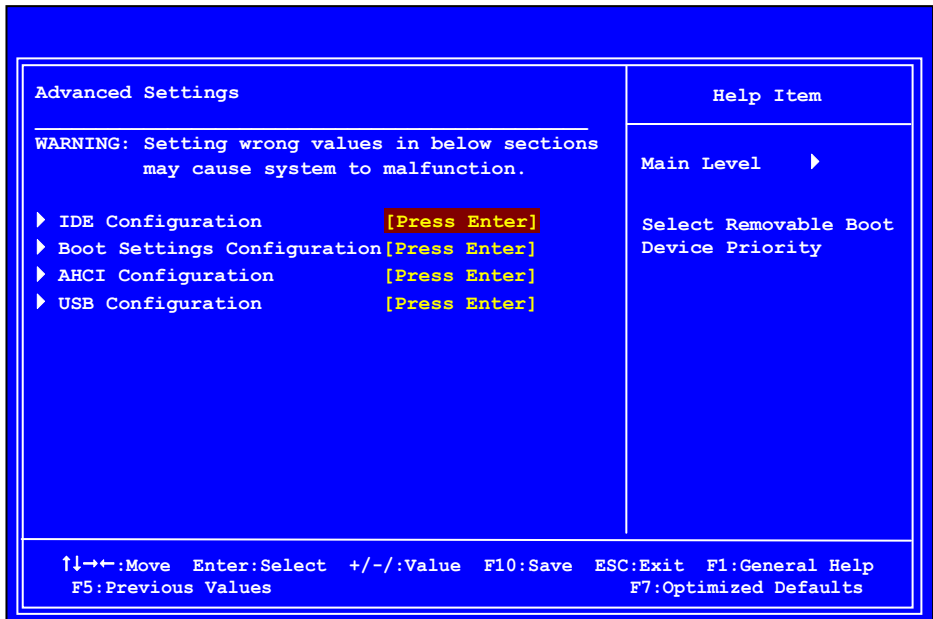

Figure 4. Advanced BIOS Features

IDE Configuration

Use this to configure your storage drivers and to enable RAID or switch between IDE and AHCI mode. Please note for Windows Vista / Windows 7, it is recommended to use AHCI mode for new system installations.

Boot Settings Configuration

Use this option to configure various system options, such as Bootup Num-Lock status, Quiet Boot and other advanced features.

AHCI Configuration

This menu will allow you to change advanced AHCI settings, such as S.M.A.R.T. status and more.

USB Configuration

This option menu allows you to enable Legacy USB support, force USB 1.1 mode and more.

Advanced Chipset Features

Select Advanced Chipset Features from the CMOS Setup Utility menu and press **Enter** to change the settings.

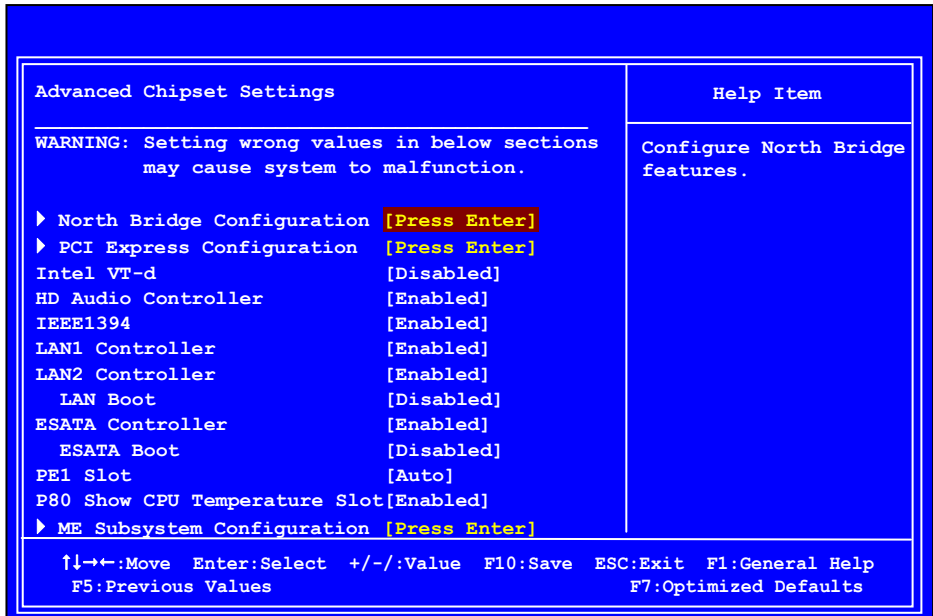

Figure 5. Advanced Chipset Features

North Bridge Configuration

This option menu will allow you to set the primary graphics adapter, and more.

PCI Express Configuration

This option menu will allow you to set advanced PCI Express options, such as Payload size. It is not recommended to adjust these settings.

Intel VT-d Configuration

This option will allow you to enable/disable the Intel VT-d feature.

The Advanced Chipset Features menu also allows you to enable/disable some onboard devices, they are as follows:

❑ **HD Audio Controller**

Use this function to set the onboard audio function. It is recommended to leave this enabled, unless you are using an external sound, add-on sound card.

❑ **IEEE1394**

This function allows you to enable or disable the IEEE1394 (Firewire) interface.

❑ **LAN1 Controller**

This function allows you to enable or disable the onboard primary network controller. It is recommended to leave this enabled, unless you are using an external Network Controller, such as an EVGA Killer Xeno card.

❑ **LAN2 Controller**

This function allows you to enable or disable the onboard secondary network controller. It is recommended to leave this enabled, unless you are using an external Network Controller, such as an EVGA Killer Xeno card.

❑ **ESATA Controller**

This function allows you to enable or disable the SATA interface.

❑ **PE1 Slot**

This function allows you to enable or disable the PE1 Slot.

❑ **P80 Show CPU Temperature**

When this function is enabled the onboard Post Port LED will display the CPU temperature.

ME Subsystem Configuration

Select this option to change advanced ME Subsystem settings.

PCI/PNP Resource Management

Select PCI/PNP Resource Management from the CMOS Setup Utility menu and press **Enter** to display the advanced settings.

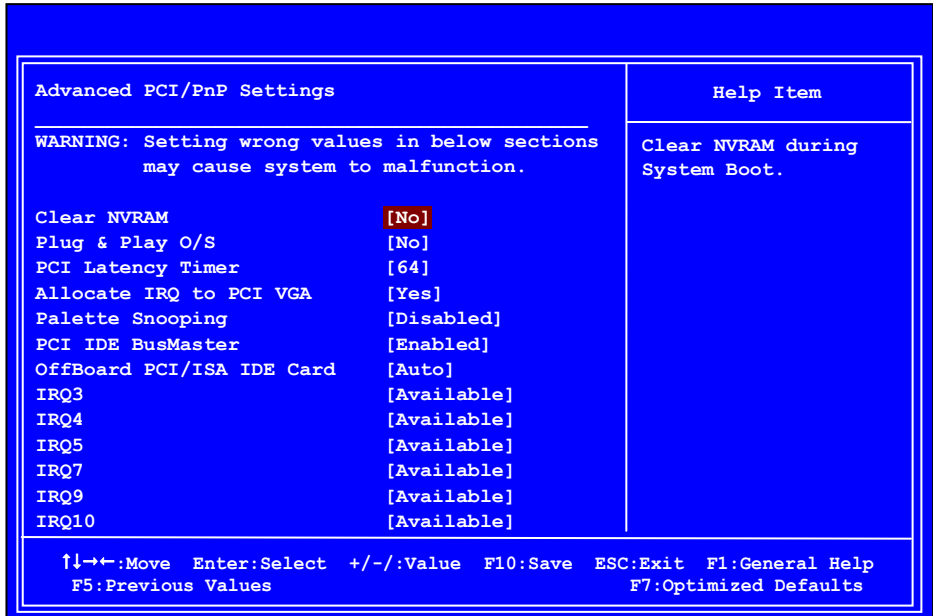

Figure 6. PCI/PNP Resource Management

Clear NVRAM

This function clears the NVRAM during System Boot.

Plug & Play O/S

This function sets whether the O/S or BIOS configures Plug and Play devices. A setting of [No] is default.

PCI Latency Timer

This function sets the value in units of PCI clocks.

Allocate IRQ to PCI VGA

This function allows an IRQ to be assigned to a PCI VGA.

Palette Snooping

This function allows the BIOS to inform the system that an ISA graphics device is installed.

PCI IDE BusMaster

This function allows the BIOS to use PCI BusMastering for reading or writing to IDE drives.

OffBoard PCI/ISA IDE Card

This function allows manual override of PCI/ISA external cards. A setting of [Auto] works for most devices.

IRQ Settings

The various IRQ settings allows you to reserve IRQ's if necessary, it is recommended to leave this as Available.

DMA Channel

The various DMA settings allow you to specify a DMI to be used by PCI/PnP devices.

Reserved Memory Size

This option allows you to specify the size of the memory block to reserve for legacy ISA devices.

Boot Configuration Features

Select Boot Configuration Features from the CMOS Setup Utility menu and press **Enter** to display the settings.

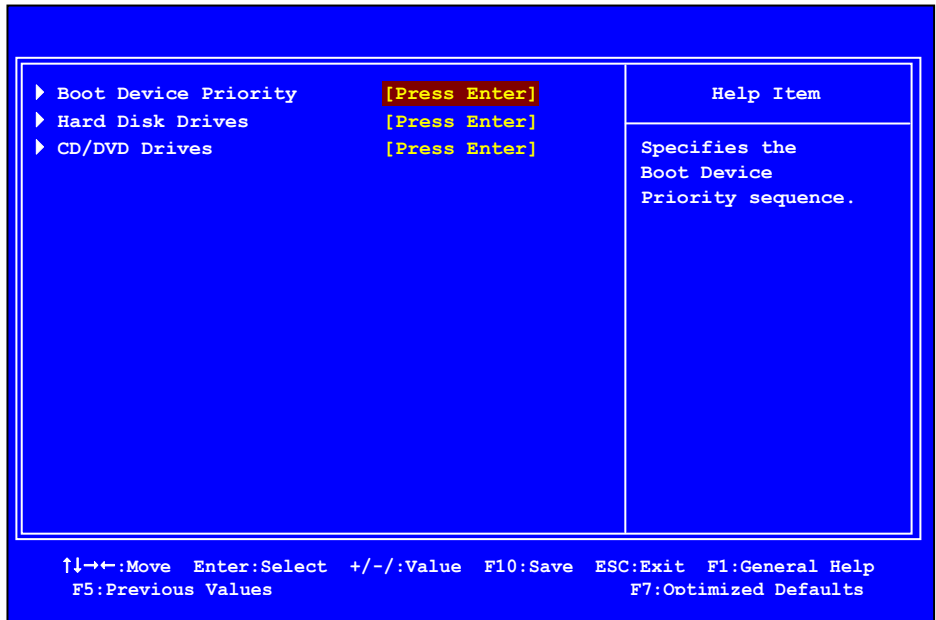

Figure 7. Boot Configuration Features

Boot Device Priority

This option menu will allow specification of the boot device priority sequence.

Hard Disk Drives

This option menu allows you specification of the Hard Disk boot priority sequence.

CD/DVD Drives

This option menu allows you specification of the CD/DVD boot priority sequence.

Power Management Features

Select Power Management Features from the CMOS Setup Utility menu and press **Enter** to display the settings.

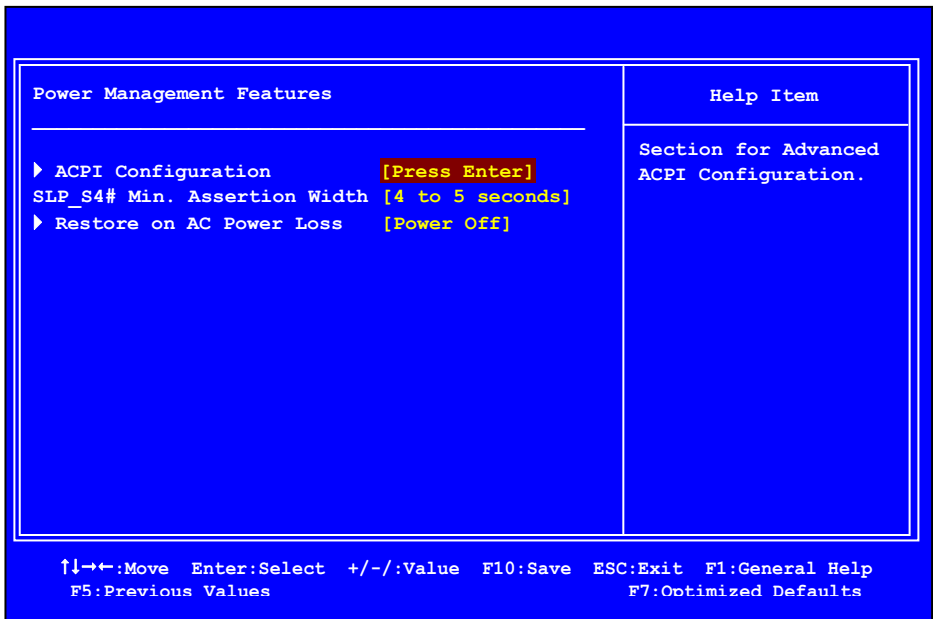

Figure 8. Power Management Features

ACPI Configuration

This menu will allow adjustment of Advanced ACPI configurations.

SLP_S4# Min. Assertion Width

This function allows adjustment of the SLP assertion width.

Restore on AC Power Loss

This menu allows adjustment of the AC Power Loss parameters.

Hardware Health Configure

Select Hardware Health Configure from the CMOS Setup Utility menu and press **Enter** to display the settings.

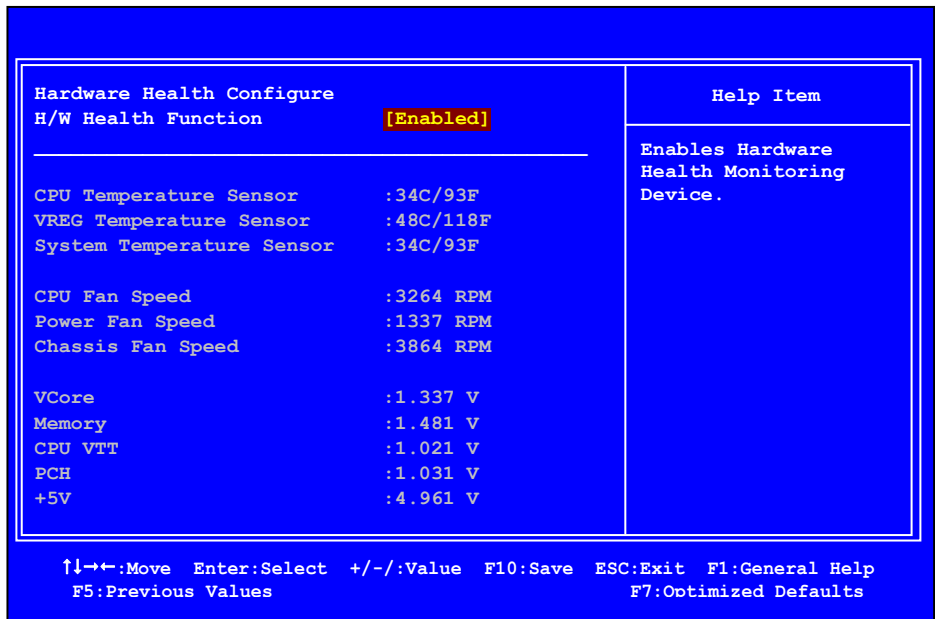

Figure 9. Hardware Health Configure

H/W Health Function

This will enable or disable Hardware Health Monitoring.

CPU Fan Mode Setting

This function allows change of the fan mode configuration.

Frequency/Voltage Control Menu

Select Frequency/Voltage Control from the CMOS Setup Utility menu and press **Enter** to display the settings.

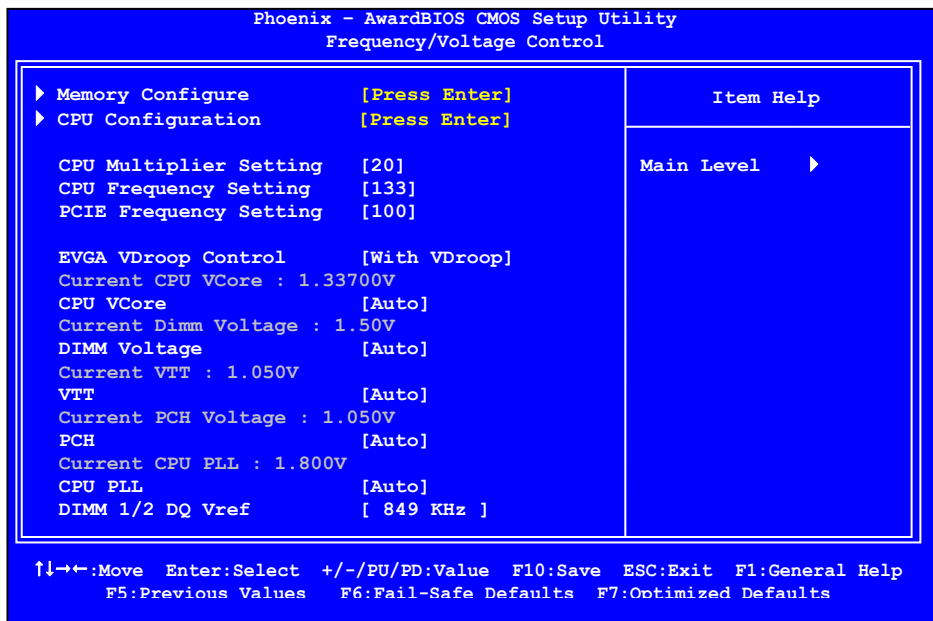

Figure 10. Frequency/Voltage Control

Memory Configure

This menu will allow the configuration of advanced memory timings, including memory frequency and memory timings.

CPU Configuration

This menu will allow the configuration of advanced CPU settings, such as Virtualization Technology, CPU SpeedStep, or CPU power saving options.

Installing Drivers and Software

The CD that has been shipped with the EVGA P55 SLI Motherboard contains the following software and drivers:

- ❑ Chipset Drivers
- ❑ Audio drivers
- ❑ LAN Drivers
- ❑ RAID Drivers
- ❑ EVGA E-LEET Overclocking Utility
- ❑ Adobe Acrobat Reader
- ❑ User's Manual

Windows XP/Vista/7 Driver Installation

5. Insert the Intel P55 installation CD for the motherboard included in the kit.
6. The CD will autorun, install the drivers and utilities listed on the install screen.

If the CD does not run, go to My Computer and click on the CD to open.

Appendix A. POST Codes for the EVGA P55 SLI Motherboard

This section provides the AMI POST Codes (Table 6) for the EVGA P55 SLI Motherboard during system boot up.

The POST Codes are displayed on the Debug LED readout located directly onboard the motherboard.

This Debug LED will also display current CPU temperatures after the system has fully booted into the Operating System.



Debug LED with CPU Temperature Monitor

Table 6. AMI POST Code

Code	Description
03	Initialize BIOS.
04	Check Battery Power and CMOS
05	Initialize interrupt controlling hardware/vector table
06	Initialize system timer
07	Fixes CPU POST interface calling pointer
08	Primary initialization of CPU
C0	Secondary initialization of CPU
C1	Set up boot strap processor information
C2	Set up boot strap processor for POST
C5	Enumerate and set up application processors
C6	Re-enable cache for boot strap processor
C7	Early CPU initialization exit
0A	Initialize keyboard controller
0B	Detect Mouse
0C	Detect Keyboard
0E	Test input devices
13	Early POST initialization of chipset registers

Code	Description
20	Relocate System Management interrupt vector
24	Uncompress and initialize BIOS module
2A	Initialize devices primary
2C	Initialize devices secondary
2E	Initialize output devices
31	Allocate memory for ADM module
33	Initialize silent boot module
37	Display sign-on message
38	Initialize USB controller
39	Initialize DMAC-1 & DMAC-2
3A	Initialize real time clock
3B	Test system memory
3C	Initialization of chipset registers
40	Detect coprocessor
52	Update CMOS memory size
60	Initialize NUM-LOCK
75	Initialize Int-13
78	Initialize IPL devices
7C	Generate and write contents of ESCD
84	Log errors encountered
85	Display errors, if no display check monitor/video card
87	Execute BIOS setup if needed or requested
8C	Late POST initialization of chipset registers
8D	Build ACPI tables
8E	Program peripheral parameters
90	Initialize system management interrupt
A1	Prepare for system boot
A2	Initialize IRQ routing table
A4	Display boot option popup
A7	Display system configuration screen
A9	Wait for user input at configuration display

Code	Description
AA	Uninstall POST vector
AB	Prepare BBS for Int 19 boot
AC	End of POST initialization
B1	Save system context for ACPI
00	Pass control to OS
(can vary)	Show CPU Temp (if enabled)

EVGA Glossary of Terms

ACPI - Advanced Configuration and Power Interface

AFR – Alternate Frame Rendering

APIC - Advanced Programmable Interrupt Controller

BIOS - Basic Input Output System

CD-ROM - Compact Disc Read-Only Memory

CMOS - Complementary Metal-Oxide Semiconductor

CPU – Central Processing Unit

D-ICE – Dry Ice Cooling

DDR2 - Double Data Rate 2

DDR3 - Double Data Rate 3

DIMM - Dual In-line Memory Module

DRAM - Dynamic random access memory

DVD - Digital Versatile Disc

DVI – Digital Video Interface

FDC - Floppy Disk Controller

FSB – Front Side Bus

FTW – For The Win!

GHz – Gigahertz

GPU – Graphics Processing Unit

HDD - Hard Disk Drive

HDMI - High-Definition Multimedia Interface

HDR – High Dynamic Range Lighting

HPET - High Precision Event Timer

HT – Hyper-Threading

HSF - Heat Sink Fan

I/O - Input/Output

IDE - Integrated Drive Electronics

IEEE - Institute of Electrical and Electronics Engineers

IGP - Integrated Graphics Processors

IRQ - Interrupt Request

JBOD - Just a Bunch of Disks

JEDEC - Joint Electron Device Engineering Council

LAN - Local Area Network

LCD - Liquid Crystal Display

LGA – Land Grid Array

LN2 – Liquid Nitrogen Cooling

MAC - Media Access Control

MCP - Media and Communications Processor

MHz - Megahertz

NB - Northbridge

NCQ - Native Command Queuing

NIC - Network Interface Card

NTFS - New Technology File System

OEM - Original Equipment Manufacturer

PATA - Parallel Advanced Technology Attachment

PCB - Printed Circuit Board

PCI - Peripheral Component Interconnect

PCIe - Peripheral Component Interconnect Express

PCI-x - Peripheral Component Interconnect Extended

POST – Power on Self Test

PWM – Pulse Width Modulation

QDR - Quad Data Rate

QPI – Quick Path Interconnect

RAID - Redundant Array of Inexpensive Disks

RGB - Red Green Blue

SATA - Serial Advanced Technology Attachment

SB - Southbridge

SCSI - Small Computer System Interface

SFR – Split Frame Rendering

SLI - Scalable Link Interface

SPD - Serial Presence Detect

SPDIF - Sony/Philips Digital Interconnect Format

SPP - System Platform Processors

TCP/IP - Transmission Control Protocol/Internet Protocol

USB - Universal Serial Bus

VDroop - V-core Voltage Drop

VGA - Video Graphics Array